



HUB-GM400

Operating Instructions

Valid SIINEOS version: from 2.10.0
Document version 1.0 | Publication date:
23. April 2026

Table of Contents

Legal information	3
1. General information	5
1.1. Scope of delivery	5
1.2. Recommended accessories	5
1.3. Other applicable documents	5
1.4. Disposal	5
2. General product information	6
2.1. Intended use	6
2.2. SIINEOS system software	6
2.3. Hardware – design and interfaces	7
2.3.1. USBs	8
2.3.2. Connection assignment of digital and analogue interfaces IO1 and IO2	9
2.3.3. Power supply	9
2.3.4. LED display	10
2.3.5. Connection assignment of the CAN interface	11
2.3.6. Connection assignment of the RS485 interface	12
3. Assembly	13
3.1. Mounting the device on the DIN rail	13
3.2. Installing additional modules on the master gateway	13
3.3. Dismantling the device	14
4. Installation	15
4.1. Connecting a power-supply unit	15
5. First steps with SIINEOS	16
5.1. Connecting HUB-GM400 with the PC	16
5.2. Logging on to SIINEOS	17
5.2.1. When logging on to SIINEOS for the first time	17
5.2.2. If you have already set up SIINEOS	17
5.3. Checking the SIINEOS version	17
5.4. Installing SIINEOS updates	18
5.5. Managing licences	19
5.5.1. Requesting a voucher and activating a software licence	19
5.5.2. Adding a licence file to SIINEOS	21
6. Setting up connected devices and communication protocols	22
7. Technical data	23
7.1. Specification of inputs and outputs	25
7.2. USB interface specifications	27
7.3. CAN interface specification	28
7.4. RS485 interface specification	28
7.5. Backplane bus specification	28

Legal information

Safety information

This documentation contains information that you must observe for your personal safety and to prevent material damage. Read the safety information carefully and always keep this documentation within easy reach.

The safety information is presented in descending order of hazard level as follows:

**DANGER**

Indicates an immediate hazard to humans. Failure to comply will lead to irreversible injuries or death.

**WARNING**

Indicates an identifiable hazard to humans. Failure to comply may lead to irreversible injuries or death.

**CAUTION**

Indicates an identifiable hazard to humans or potential material damage. Failure to comply may lead to reversible injuries or material damage.

**ATTENTION**

This gives you information that may lead to material damage if not complied with.

**NOTE**

A note gives you useful information on specific actions and issues.

**TIP**

A tip gives you tips, tricks or recommendations from in.hub that have proven to be helpful in handling the products.

Qualified personnel

The product associated with this documentation may only be handled by personnel qualified for the respective task. The device may only be installed, commissioned and operated in compliance with the associated documentation and the safety information contained therein.

Based on their training and experience, qualified personnel are able to recognize risks and avoid potential hazards when handling these products.

Knowledge of PCs, operating systems and web applications is a prerequisite. General knowledge in the field of automation technology is recommended.

Intended use

The HUB-GM400 is intended exclusively for use in the industrial sector and is used for monitoring machines, systems and processes. Process data can be recorded, processed, controlled and analysed using the connection options provided.

in.hub products may only be used for the applications specified in the corresponding technical documentation.

If third-party products and components are used, they must be recommended or approved by in.hub.

Proper storage, set-up, assembly, installation, commissioning, operation and maintenance are essential for the correct and safe operation of the products.

The permissible ambient conditions must be complied with. Instructions in the associated documentation must be followed.

Brands

All designations marked with the “®” symbol are registered trademarks. The other designations in this document may be trademarks whose use by third parties for their own purposes may infringe the rights of the owner.

Disclaimer

in.hub accepts no liability for product malfunctions resulting from improper handling, mechanical damage, incorrect application and improper use.

The contents of this document have been checked for conformity with the product described. However, deviations cannot be ruled out, so that we cannot guarantee complete conformity. The information in this publication is regularly reviewed. Necessary corrections are included in subsequent editions.

1. General information

This document contains all the information you need to commission and use the device/software.

The document is intended for service technicians, system administrators and installers who connect the product with other units, configure it and commission it.

1.1. Scope of delivery

1 x HUB-GM400

1 x Operating Instructions as a PDF

1.2. Recommended accessories

- DIN-rail bus connector (backplane connector)
Item number: A1000250
- Wi-Fi dongle: TP-Link USB Wi-Fi Adapter 5 GHz / 2.4°GHz
Item number: A1000243
- 4G LTE industrial USB modem (EU)
Item number: A5000017
- USB flash drive HUB-RT100 with real-time clock
Item number: A5000021

1.3. Other applicable documents

In addition to this document, please observe the following documents. You can find these in the in.hub download portal at <https://download.inhub.de>:

- User Manual for the IoT (Internet of Things) operating system SIINEOS
- Operating Instructions for other devices that you wish to plug in or connect

1.4. Disposal

Please observe the national regulations.

Do not dispose of the device with normal household waste, but appropriately for its nature and country-specific regulations, e.g. as waste electrical and electronic equipment (WEEE) or by commissioning a certified disposal company.

2. General product information

The HUB-GM400 IoT gateway has a variety of interfaces to permit connection of machine and industrial controllers, modules and sensors directly to the gateway. With in.hub's own operating system SIINEOS, you can fulfil a wide range of operational requirements and integrate the gateway flexibly and with ease.

2.1. Intended use

The HUB-GM400 is ideal for:

- Process monitoring using machine learning / AI algorithms
- Use as a process-control computer and traceability server
- Use as a remote access point on machines and systems for remote maintenance via VPN (virtual private network) or VNC (virtual network computer) (cloud service)
- In-process parameter monitoring for:
 - Preventive maintenance
 - Machine data acquisition
 - Status and yield monitoring on production lines
 - Monitoring of environmental influences on the process to ensure compliance with standard guidelines and occupational health and safety (e.g. temperature, humidity, particle concentration)
- Individual monitoring to monitor, control or regulate specific processes.

2.2. SIINEOS system software

The HUB-GM400 uses the Linux-based SIINEOS operating system to run InCore & Docker apps. SIINEOS is accessible via a management console (SMAC) and can be configured there. All network parameters are also set up here to enable communication with other network components.

2.3. Hardware – design and interfaces

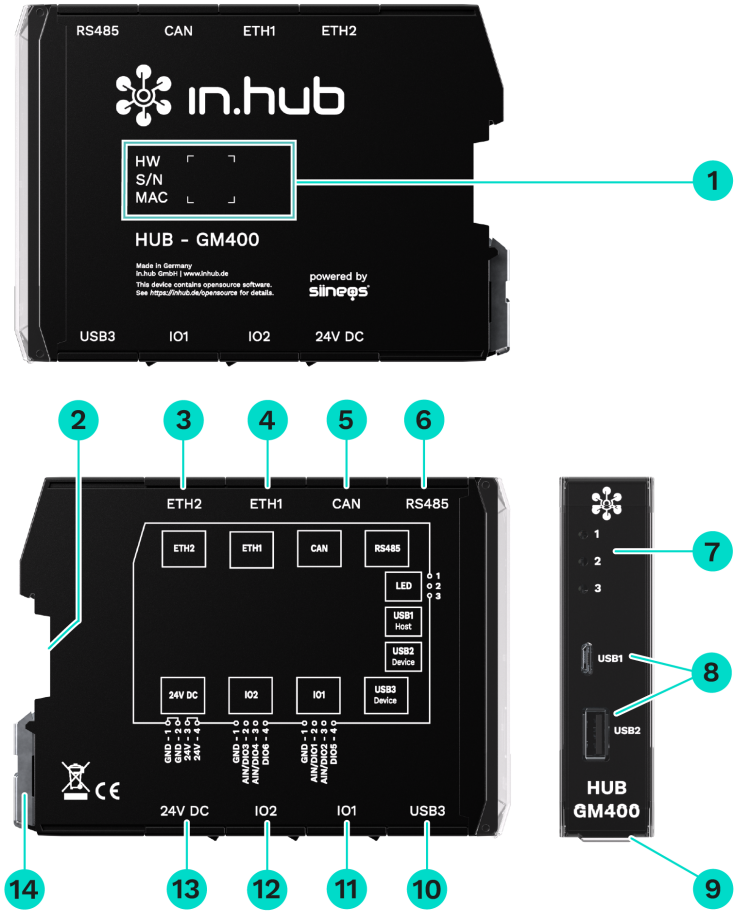

Views of the HUB-GM400 including interfaces

- 1 Device-specific information is stored in a barcode:
HW: Hardware revision
S/N: in.hub internal serial number
MAC: Hardware addresses of the Ethernet interfaces
- 2 Backplane bus
- 3 Ethernet 2
- 4 Ethernet 1
- 5 CAN bus
- 6 RS485 bus
- 7 LEDs displaying the operating status
- 8 USB1 (host) and USB2 (device)
- 9 Protective flap
Can be opened upwards.

10	USB3 (Host)
11	IO1: digital input/output and analogue input
12	IO2: digital input/output and analogue input
13	24 V DC power supply
14	Clamping device for mounting on the DIN rail

2.3.1. USBs

The technical parameters of the USB interfaces can be found in the chapter [USB interface specifications \[27\]](#).

- Open the protective flap on the front upwards to access the two USB ports.
- The **USB1** port (host) is a Micro-USB port.
- The **USB2** and **USB3** ports (device) are type-A sockets.
- The Micro-USB connection **USB1** on the front of the device is only suitable for setting parameters and short-term power supply of the assembly – not as a permanent supply.



NOTE

Under certain circumstances, the power supply via USB1 (host) may not be sufficient, e.g. with additional, energy-hungry USB devices connected to a USB port (device), with high computing power and/or if the rating of the USB port of your connected device is too low.

2.3.2. Connection assignment of digital and analogue interfaces IO1 and IO2

The technical parameters of the interfaces can be found in the chapter [Specification of inputs and outputs \[25\]](#).

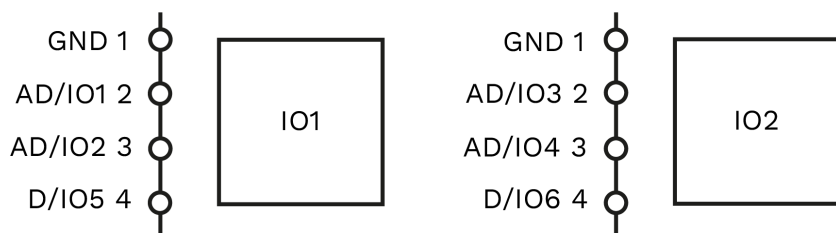

Schematic diagram of the IO1 and IO2 interfaces

Pin	Signal IO1	Signal IO2	Description
1	GND	GND	Ground / 0 V
2	AD/IO1	AD/IO3	Configurable in SIINEOS as an analogue <u>or</u> digital input – or – a digital output
3	AD/IO2	AD/IO4	
4	D/IO5	D/IO6	Digital input <u>or</u> output

2.3.3. Power supply

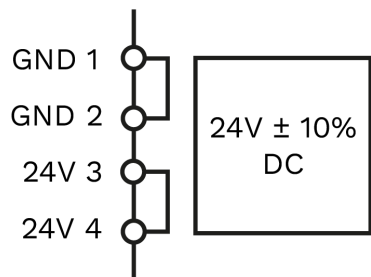

Connection assignment of the “power supply” interface

2.3.4. LED display

The three bicolour (red/green) LEDs on the front of the device indicate the following status:

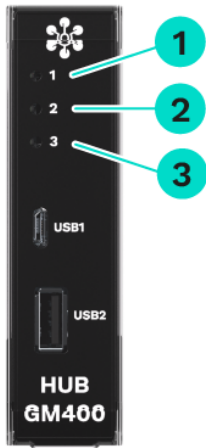

LEDs on the HUB-GM400

1	Device status
2	Communication LED, configurable in SIINEOS in the device settings
3	Status LED, configurable in SIINEOS in the signal settings LED for device identification

Behaviour of LED 1	Colour	Meaning
LED off	–	Device is out of order
Lights up briefly	Red	Memory access
Flashing in heartbeat mode	Green	Module ready for operation
Permanently lit	Green	Error in the boot process

Behaviour of LED 3	Colour	Meaning
20 x 1 Hz flashes	Red	The Device identification action has been triggered in the SIINEOS of the HUB-GM400.

2.3.5. Connection assignment of the CAN interface



NOTE

By default, this interface is permanently installed with terminating resistance. You should therefore install the module at the end of a bus structure and rewire the device that was previously terminating.

Front

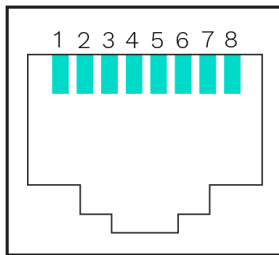

Schematic diagram of the CAN bus

Pin	Signal	Description
1	CAN-H	CAN-HIGH / CAN+
2	CAN-L	CAN-LOW / CAN-
3	CAN-GND	Ground / 0 V
4	–	Not assigned
5	–	Not assigned
6	–	Not assigned
7	GND	Ground / 0 V
8	24 V	Power supply NOTE: Pin 8 for the power supply must be activated in the software. NOTE: Voltage at pin 8 = voltage of the power supply unit minus 0.5 V.

The technical parameters of the CAN interface can be found in the chapter [CAN interface specification \[28\]](#).

2.3.6. Connection assignment of the RS485 interface



NOTE

By default, this interface is permanently installed with terminating resistance. You should therefore install the module at the end of a bus structure and rewire the device that was previously terminating.

Front

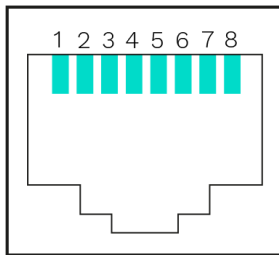

Schematic diagram of the RS485 bus

Pin	Signal	Description
1	–	Not assigned
2	–	Not assigned
3	–	Not assigned
4	B	B' / D+ / D1 / RXTX+ / RXTX-P / DP
5	A	A' / D– / D0 / RXTX– / RXTX-N / DN
6	–	Not assigned
7	24 V	Power supply NOTE: Pin 7 for the power supply must be activated in the software. NOTE: Voltage at pin 7 = voltage of the power supply unit minus 0.5 V.
8	GND	Ground / 0 V

The technical parameters of the RS485 interface can be found in the section [RS485 interface specification \[28\]](#).

3. Assembly

The HUB-GM400 must be installed on a DIN EN 60715 (35 mm) mounting rail. Observe the applicable safety and accident prevention regulations for specific areas of application, such as the Machinery Directive.



CAUTION

Electric shock due to conductive dirt can cause personal injury!

- If possible, work with the power supply switched off.
- Avoid conductive contamination.
- Only install devices in a control cabinet with the appropriate protection class.



RECOMMENDATION

Maintain a minimum distance of 25 mm between the cable duct and the edge of the housing. This applies to both the top and bottom edges. This makes installation easier.

3.1. Mounting the device on the DIN rail

1. Make sure that the system's power supply is disconnected.
2. Turn the module so that the mounting foot (metal clamping device) is pointing downwards.
3. Hold the device at an angle to the DIN rail.
The recess on the back of the module is located above the mounting foot.
4. Click the module onto the DIN rail until you hear the mounting foot click into place.
5. After installation, check that the device sits firm and straight on the DIN rail.

3.2. Installing additional modules on the master gateway

The HUB-GM400 can be connected to various modules via a backplane bus, e.g. the HUB-VM102 or the HUB-EN200. All additional devices are attached to the right of the HUB-GM400 and connected to a DIN-rail bus connector. The backplane bus supplies the modules with power and enables data communication between gateway and module.

1. Make sure that the system's power supply is disconnected.
2. Make sure that a DIN-rail bus connector is attached to the HUB-GM400.
3. Put another DIN-rail bus connector onto the DIN rail and push it along the DIN rail until directly next to the master gateway
4. Click the extension module onto the DIN-rail bus connector you have just attached.



HUB-GM400 as master gateway with a HUB-VM102 as an extension

3.3. Dismantling the device

1. Make sure that the system's power supply is disconnected.
2. Use a screwdriver to pull the mounting foot (metal clamping device) downwards and remove the module from the DIN rail.



Removing the HUB-GM400 from the DIN rail

4. Installation

Read these instructions carefully and observe the safety instructions and warnings provided.

4.1. Connecting a power-supply unit



CAUTION

An incorrect power supply can cause irreparable material damage.

- Ensure that the power supply complies with the nominal voltage (of 24 V \pm 10%).

1. To make installation easier, you can remove the plug with the terminal contacts from the **24 V DC** interface.
2. Clamp the power connection cable into the plug. Observe the following schematic diagram when doing this:

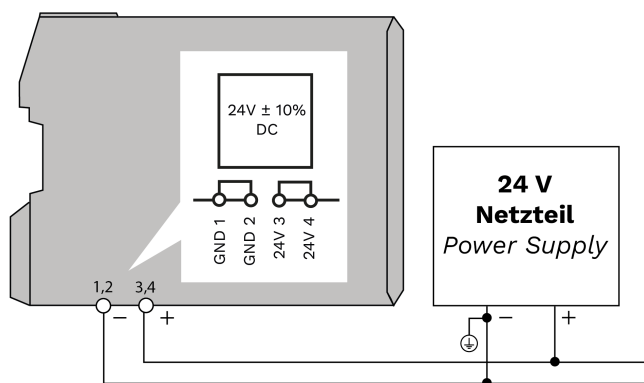

Schematic diagram of the power supply

When the operating voltage is correctly applied, the status LEDs on the front of the module light up – depending on the configuration – and signal the booting (start-up) of the SIINEOS system software.

5. First steps with SIINEOS

This chapter contains the first steps for your work with SIINEOS. Details on the configuration and settings of your device in SIINEOS are described in separate user documentation, which is published with each new software version of SIINEOS. This allows you to benefit from new features and improvements in the SIINEOS software.



NOTE

SIINEOS updates and the user documentation can be downloaded from the download portal at <https://download.inhub.de/siineos/>.

5.1. Connecting HUB-GM400 with the PC

1. Use a Micro-USB cable to connect your PC with the HUB-GM400.

In most cases, the USB connection provides enough power to operate the HUB-GM400 without having to connect an extra power supply.



NOTE

Under certain circumstances, the power supply via USB1 (host) may not be sufficient, e.g. with additional, energy-hungry USB devices connected to a USB port (device), with high computing power and/or if the rating of the USB port of your connected device is too low.

LED 1 indicates the status of the device. If the connection is working correctly, **LED 1** lights up and flashes after a while. SIINEOS runs on the module.

2. When you connect the HUB-GM400 for the first time, additional drivers are installed. Check Windows Device Manager to see if a new device has been created:

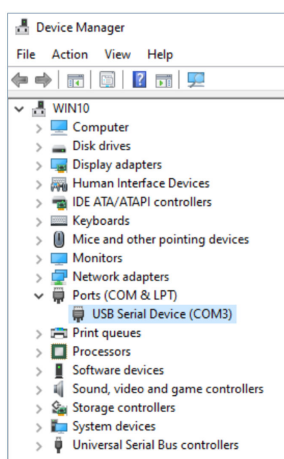

Windows Device Manager (example)



NOTE

If the LED display does not light up and no drivers have been installed and no new device created, there is usually an insufficient power supply to the module. In this case, use an external power supply at the 24 V input.

5.2. Logging on to SIINEOS

We recommend that you use the latest versions of the **Firefox**, **Edge** or **Chrome** browsers for SIINEOS. Compatibility problems may occur with other or older browsers.

5.2.1. When logging on to SIINEOS for the first time

1. Connect the gateway or module to your PC using a micro USB cable (USB port on the front of the device).
2. Enter the following address in your browser:
<http://192.168.123.1>
3. Log on with the initial user data (**hubadmin/hubadmin**).
The SIINEOS Management Console opens.



SIINEOS start page (example)

On the start page, you will now see information about your system, such as the current SIINEOS version, the device name, location, type, system resources, etc.

4. Select the **Users** page and change the password for the user **hubadmin**.

5.2.2. If you have already set up SIINEOS

1. In your browser, enter the individual IP network address that you have configured.
2. Log on with your user data and click on **Log in**.
The SIINEOS Management Console opens.

5.3. Checking the SIINEOS version

1. Go to the SIINEOS start page by selecting the **Overview** page on the left.

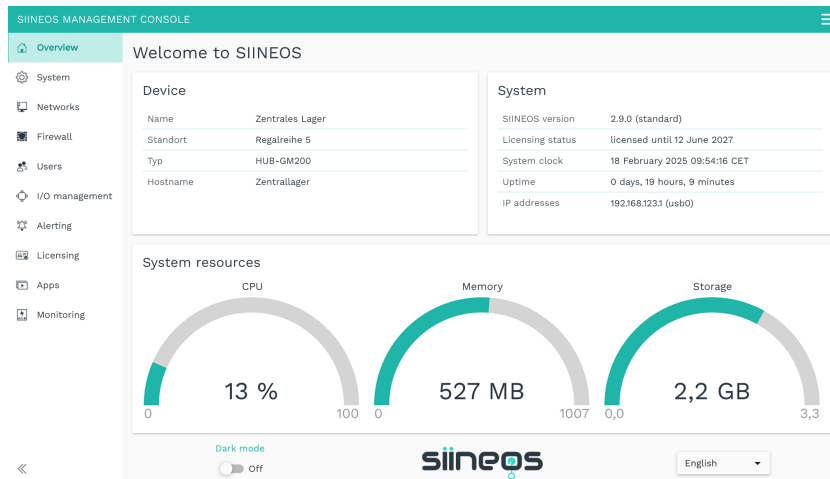

“Overview” start page (example)

2. Check the **SIINEOS version** field to see which version is installed on your gateway.
3. Go to the download portal at <https://download.inhub.de/siineos/> and check whether a new version of SIINEOS is available.

5.4. Installing SIINEOS updates



NOTE

You can only upload updates on the **System** page if you have a valid SIINEOS licence.

If the licence has expired, you will be informed that you cannot import any updates.

1. Go to the download portal at <https://download.inhub.de/siineos/> and select the required SIINEOS package.
Two variants are available:
 - The complete software package in 64-bit architecture for the HUB-GM400 and the HUB-CX400
 - The complete software package in 32-bit architecture for modules, such as the HUB-GM200 or the HUB-EN200
 - SIINEOS Light without Docker containers with a smaller file size for the HUB-IO100
2. When the download is complete, go to the **System** page in SIINEOS and select **Updates**.

System > Updates

Offline update

Update image file

Click here to select a local file to upload and install.

UPLOAD AND INSTALL

System > Updates

3. Click in the **Update image file** input field and select the software package provided by in.hub in *.raucb format from your local file-storage location.
4. Click on **Upload and install**.
The installation will proceed automatically and takes about 1 minute. After a successful installation, you will be asked whether you want to restart the gateway.
5. Click on **Yes**.
6. After restarting, check that the new version of SIINEOS is displayed on the **Overview** page.
7. If the version has not been updated, proceed as follows:
 - a. First delete your browser cache and refresh the page in your browser.
 - b. if that doesn't work: Switch off the power to the gateway and switch it on again after a few seconds.
 - c. Start SIINEOS and check the version number.

5.5. Managing licences

With every new SIINEOS-enabled device you purchase, you will automatically receive a SIINEOS licence for 3 years. You can update SIINEOS as often as you like during the licence period and install the latest version on the device.

Once the licence period has expired, you can either continue working with the currently installed version of SIINEOS or you can purchase another licence from in.hub to benefit from the further development and product improvement of SIINEOS.

If you need an app licence or want to extend one, please refer to the relevant User Manual.

5.5.1. Requesting a voucher and activating a software licence

1. Please contact service@inhub.de and let us know which licence you require.
SIINEOS licences can be purchased for 1 year or 3 years.
You can activate the software licence with the voucher you receive from us.
2. Navigate to the website <https://apps.inhub.de/> and register or log on if you are already registered.

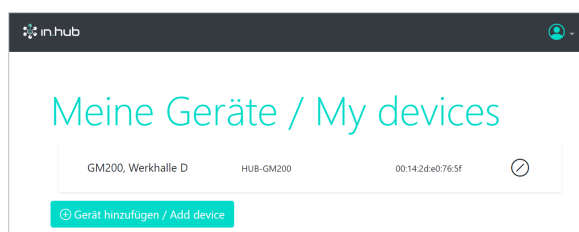

My devices (example)

3. If you want to extend a software licence, click on the device on which the software licence is to be renewed under **My devices**;
– or –

if you want to activate the software licence for a new device, click on **Add device**.

Gerät hinzufügen / Add device

Name*

Gerätetyp / Device type*

MAC-Adresse*

Add device

4. Enter the **Name** of the device, select the **Device Type** and enter the MAC address of the device.

The MAC address can be found via **SIINEOS > Networks > Ethernet 1**.

NOTE: Only the MAC address of Ethernet 1 is recognized and accepted.

5. Click on **Add**.

The **License activation** page opens:

Lizenzfreeschaltung / License activation

Bitte geben Sie einen Lizenzvoucherein, um ihn einzulösen und die erworbene Softwarelizenz für dieses Gerät zu aktivieren. Wenn Sie keinen Voucher haben, wenden Sie sich bitte an den Händler, bei dem Sie das Gerät erworben haben.

Please enter a license voucher to redeem it and activate the purchased software license for this device. If you do not have a voucher, please contact the dealer from whom you purchased the device.

Gerät / Device

Voucher

License activation

6. Copy the name of the voucher you received from in.hub into the **Voucher** field.

7. Click on **Next**.

The information stored in the voucher, such as the term, product and validity, etc., will be displayed.

Lizenfreischaltung / License activation

Voucherinformationen / Voucher information

Gerätename / Device type: GM200, Werkhalle D

Produkt / Product: SIINEOS

Lizenztyp / License type: 3 Jahre

Gültig bis / Valid until: 16.04.2027

Abbrechen / Cancel Zurück / Back Lizenz generieren / Generate license

Voucher information (example: Activation of a SIINEOS licence valid for 3 years)

8. Check the details, especially whether the requested licence term matches the term specified here.
9. If the details are correct, click on **Generate license**.
The licence file is downloaded automatically.

5.5.2. Adding a licence file to SIINEOS

1. In SIINEOS, navigate to **Licensing**.
In the list, you will find all software licences that you have purchased and uploaded. The check mark in the first column indicates that the licence is valid.

SIINEOS MANAGEMENT CONSOLE

Overview

System

Networks

Firewall

Users

I/O management

Alerting

Licensing

Apps

Monitoring

REMOVE

License ID	Product	Size	Valid from	Valid until	Licensee	
<input checked="" type="checkbox"/>	d7f8da27	MaDoW	4	19 June 2025	19 June 2026	in.hub GmbH, service@inhub.de
<input checked="" type="checkbox"/>	6a928e05	SIGNL4	1	23 April 2025	23 April 2027	
<input checked="" type="checkbox"/>	9640bb23	SIINEOS	1	12 June 2024	12 June 2027	in.hub GmbH, service@inhub.de
<input checked="" type="checkbox"/>	bedbd72e	TOSIBOX Lock for Container	1	25 March 2025	25 March 2028	in.hub GmbH, service@inhub.de

“Licensing” page (example)

2. Click on **Add license**.
3. Select the licence file from your file directory and click on **OK**.
The licence is added to the list. From that point on, you can implement updates again or return to using a blocked app.
4. To remove a licence again – because it has become invalid, for example – select the licence ID and click on **Remove**.
This will not delete the licence file itself, but only remove it from the list.



NOTE

Make sure that the system time of your device is correctly set and/or synchronized. Otherwise, the licence-file upload may fail.

6. Setting up connected devices and communication protocols

1. Please refer to the SIINEOS User Manual.
You can find the current document at <https://download.inhub.de/siineos/>.
2. In the **I/O management** section under **I/O units**, find the device that you have connected and now want to set up or select one of the communication protocols (MQTT, Modbus, OPC UA).
3. Go through the instructions step by step as explained in the User Manual.
4. If something does not work straight away, the following two first-aid options are available to you:
 - a. Check the **Troubleshooting** section in the User Manual to see whether the problem you have encountered is described there. You can also use the full text search in the PDF. The cause may lie in a setting on the device, e.g. in the Firewall or in the network settings.
 - b. Check whether the problem has already been discussed in the community at <https://community.inhub.de/>. If not, please feel free to ask a question yourself.

7. Technical data

Data	
Power supply	24 V DC \pm 10 %
Max. power consumption	150 W
Processor	NXP® i.MX 8QuadMax, 4 x ARM Cortex-A35
Memory	2 GB LPDDR4 RAM, 8 GB eMMC
Data interfaces	USB1: Host (Micro USB) USB2: Device (USB-A) USB3: Device (USB-A) 2 x Ethernet: 100 Mbit/s 1 x CAN 1 x RS485 3 x status LEDs Backplane bus
Connections for peripheral devices	A total of 6 interfaces in IO1 and IO2, configurable in SIINEOS: up to 6 x as a digital input up to 6 x as a digital output up to 4 x as analogue input
Protocols	OPC UA server + client MQTT broker server + client Modbus TCP/IP broker client + server
Operating system	IIoT operating system SIINEOS (64 bit) for configuration and data visualization
Housing	Plastic (polyamide) black, flammability class UL 94 V0
Protection class	IP20
Dimensions	139 mm \times 100 mm \times 25 mm
Weight	183 g

Ambient conditions	
Temperature range	Storage: -40°C to 85°C Operation: 0°C to 50°C
Humidity	Storage: 10% to 95% RH, non-condensing Operation: 20% to 90% RH, non-condensing

Ambient conditions	
Operating altitude	Max. 2,000 m above sea level

Storage	
Recording interval	Minimum 1 second
Storage	Up to 8 GB usable
Data export	VictoriaMetrics

SIINEOS	
Pre-installed software	<p>FlexPlorer: Live data visualization</p> <p>Azure IoT Hub Connector: Connector to the Microsoft® IoT platform</p> <p>Cloud of Things Connector: Connector to the Telekom® IoT platform</p> <p>InGraf: Grafana data visualization</p> <p>NumCorder: Recording of scanned or entered barcodes / serial numbers</p> <p>OPC UA server: Counterpart to the OPC UA client, setting up of a server–client structure with one device</p> <p>NodeRED: Graphical programming of interfaces, services or hardware</p> <p>PromEx: Database configuration of VictoriaMetrics and Prometheus</p> <p>TOSIBOX®: Secure connectivity between the IoT devices</p> <p>SIGNL4 Connector: Forwarding of alarms to the SIGNL4 cloud</p>
I/O interfaces to third-party systems/devices	<p>S7 PLC client: Connector for the Siemens® S7 controller</p> <p>Sensirion SPS30: Temperature and humidity sensor</p> <p>TBEN-S1-8DIP: TBEN module from TURCK®</p> <p>TBEN-S2-4AI: TBEN module from TURCK®</p> <p>IO-Link master</p> <p>IO-Link device</p>

7.1. Specification of inputs and outputs

Configuration of DIO as a digital input	
Conformity	EN61131-2 Type 1/3
Switching threshold	Between 5 V and 11 V
Pull-down current	Typ. 2 mA
Bandwidth	From 6 Hz (with 12 channels, 2 edges) to 150 Hz (with 1 channel, 1 edge)*
Permissible input voltage range	-3 to 30 V
Circuit diagram**	

Configuration of DIO as a digital output	
Power supply	From 24 V Protective functions: Overload protection, reverse-current protection
Conformity	EN61131-2 nominal current 0.1 A
Max. output current	Typ. 120 mA
Switching interval	≥50 ms*
Voltage drop to 24 V	Max. 1 V
Circuit diagram**	

Analogue input AIN	
Operating modes	Current Voltage
Measuring range	0–11 V / 0–24 mA
Resolution	12 bit
Input resistance	101 kΩ (at 0–11 V)
Sampling interval	≥50 ms*
Permissible input voltage range	–3 to 30 V
Protective functions	Overload protection: in 20 mA mode, the current is limited to 22–30 mA
Circuit diagram**	

*Only if processor is not busy

**The hash (#) in the circuit diagram indicates the overload protection.

7.2. USB interface specifications

USB connections	
Max. power consumption for USB1 (Micro-USB on the front of the device)	5 W (1 A) May vary depending on the device connected: <ul style="list-style-type: none"> On a 24 V power supply, the power consumption is 0 On a 5 V power supply provided exclusively by USB, the digital and analogue outputs cannot be used.
Max. power output for USB2 and USB3	2.5 W (500 mA) each with 24 V supply
Support for	Full, high and low speed (480, 12 and 1.5 Mbit/s)
Circuit diagram*	

*The hash (#) in the circuit diagram indicates the overload protection.

7.3. CAN interface specification

CAN bus	
Voltage output	24 V (0.75 A) Protective functions: Reverse-polarity protection, overload protection
Max. baud rate	1 Mbit/s
Bus termination	120 Ω

7.4. RS485 interface specification

RS485 bus	
Voltage output	24 V (0.75 A) Protective functions: Reverse-polarity protection, overload protection
Max. baud rate	2.5 Mbit/s
Bus termination	120 Ω

7.5. Backplane bus specification

Backplane bus	
Voltage on the backplane bus	Voltage of the power supply unit minus 0.5 V Switchable in the signals of the master gateway Protective functions: Overload protection
Communication	Modbus RTU
Max. number of additional modules on one master gateway	3

This document is available in electronic form in the download portal of in.hub. Printed versions or copies not explicitly provided by in.hub are deemed uncontrolled.

The original language of this document is German.

Made in Germany.

Service & Support: service@inhub.de | <https://community.inhub.de>

in.hub Download portal: <https://download.inhub.de>



in.hub GmbH
Technologie-Campus 1
DE-09126 Chemnitz

+49 371 335 655 00
info@inhub.de